



EZ Port®
how fun gets on the water

There's something about being out on the water on a PWC that makes you feel truly alive. Free as the waves and the wind you're flying through, constantly in motion, feeling the flow of nature all around you, going anywhere your mood takes you.

But the wind and the waves that make PWCs so exciting are also their biggest threats while they're in port. That's why EZ Dock® created the EZ Port line of PWC ports— to protect your PWC from the elements while helping you get in and out of port as effortlessly as the wind and the waves you love.



EZ Dock revolutionized PWC docking and launching with the introduction of EZ Port[®], the original, drive-on, push-off PWC port. Our patented one-piece design pioneered the use of adaptable rollers, perfected the self-centering split entry and created the modular inline system for the simple, durable and efficient storage of multiple PWCs:

EZ PORT 2i

This patented, top-of-the line, self-centering drive-on port features a split entry and self-adjusting rollers that make loading and unloading of all PWCs smooth and effortless.

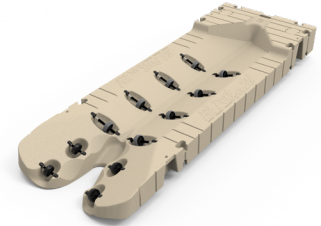

EZ PORT VXP

VALUE | XTREME | PERFORMANCE

The VXP lifts rec and rec-lite PWCs out of the water for cleaning and maintenance while also making getting on and off the port smooth, stable and easy.



EZ PORT MAX

MODULAR | ADAPTABLE | EXPANDABLE

This system of inline ports features smooth-gliding rollers for easy loading so even beginner PWC operators can board and launch with ease.



All the ports in the EZ Dock line are designed to keep your PWC safe, stable and easy to use:

- Protects against hull damage and deterioration from exposure to water, waves and boat wakes
- Multiple port design supports all PWC makes and models
- Adjusts to changing water levels
- Provides peace of mind while unattended at the dock
- Adjustable rollers adapt to all PWC brands and hull designs for effortless porting and launching
- Provides easier access for maintenance
- Board and exit your PWC easily while on the port
- Connects seamlessly with existing EZ Dock systems
- Cleans easily with soap and water, recommended pressure-washer setting, or other EPA-approved cleaners
- Adaptable to any existing dock system or standalone application

EZ PORT 2i

There's a beautiful simplicity to being out on the water. Your cares and your troubles just seem to fade into the distance, carried away effortlessly by the wind and the wake of your PWC across the water.

At EZ Dock, we believe that launching and landing your PWC should feel just as relaxing and effortless — which is why we created the EZ Port 2i, the drive-on PWC port that launched the rest of our line.





EZ PORT 2i





EZ Port 2i Drive-On Port

EZ Port revolutionized docking and launching with the EZ Port 2i, the original drive-on PWC port. This patented, top-of-the-line PWC port is the simplest and most durable drive-on, push-off method of dry docking. Its single-piece, self-centering design with split entry and self-adjusting rollers makes loading and unloading smooth and effortless, even for beginner PWC operators.

See the EZ Port 2i in action



Visit the EZ Dock YouTube channel to see why the EZ Port 2i was the first and is still the best.

EZ Port 2i Features and Benefits

- UV-16-protected, rotationally molded polyethylene
- Industry-leading impact resistance requires no environmentally harmful foam filling
- Patented understructure creates a stable and durable walking and porting surface
- Adjustable rollers adapt to all PWC brands and hull designs for effortless porting and launching
- Optional bolt-on bow stop for added security (coming in 2019)
- Seamlessly connects to any EZ Dock system
- Connects to any existing dock system or can be secured to the shore or lakebed without a dock
- Keeps any PWC high and dry, protecting your investment
- Available in beige or gray

EZ PORT 2i

The EZ Port 2i is considered the best PWC port available today. With its revolutionary self-adjusting design, this port makes loading and unloading of PWCs of any shape up to 1,700 lbs (771kg) smooth and effortless.

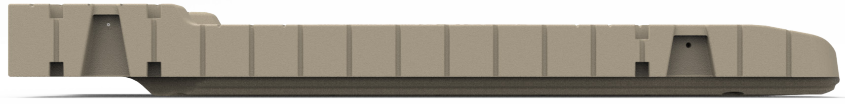
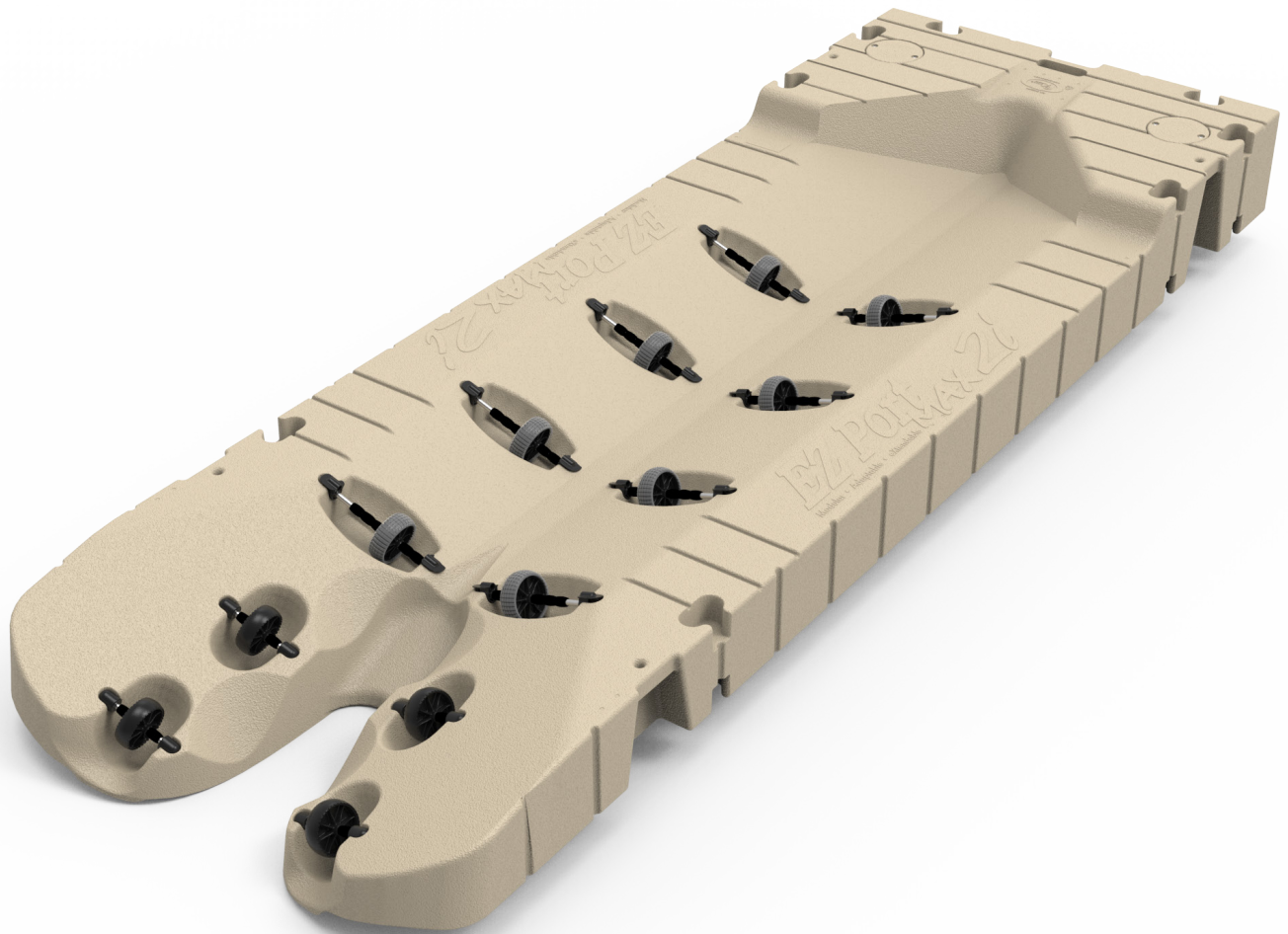

MODEL DESCRIPTION	SKU	DIMENSIONS	AREA	FLOTATION CAPACITY	WEIGHT
EZ PORT 2i	206036PW (BEIGE)	168" x 59" x 15" (4.3 m x 1.5 m x 38 cm)	68 sq ft (6.3 sq m)	1,700 lbs (771 kg)	350 lbs (146.9 kg)
	206036PW-EZGR (GRAY)				



Innovative drive-on design

Integrated mooring holes with caps

Adjustable roller system accommodates multiple hull shapes

Self-aligning and self-centering rollers move laterally for easy entry

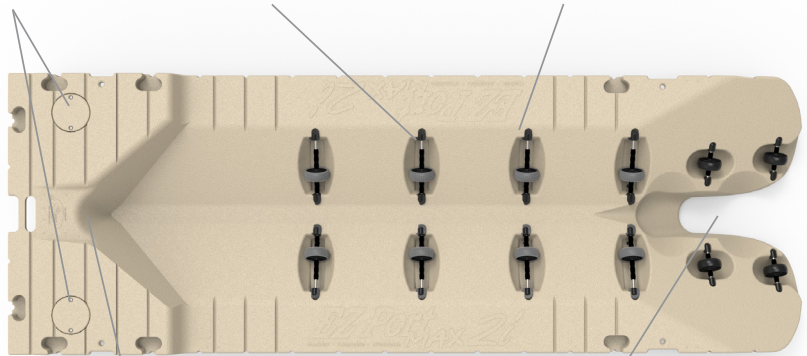

Integrated bow helps prevent overshooting

Split-entry design guides the PWC onto the port



The EZ Port 2i's revolutionary design makes driving on smooth and effortless — just Idle up, ease into the throttle, then roll to the front of the port.

EZ PORT VXP

VALUE | XTREME | PERFORMANCE

Out on the water is where the action is, so that's where you want to be. Not stuck on the dock, worrying about your PWC. Cruising the waves is just the escape you need, trading your worries for the wind in your hair, the spray of the waves in your face and adrenaline pumping through your veins.

The water is where you come alive — and the new EZ Port VXP from EZ Dock is designed to make sure that nothing stands between you and that feeling.

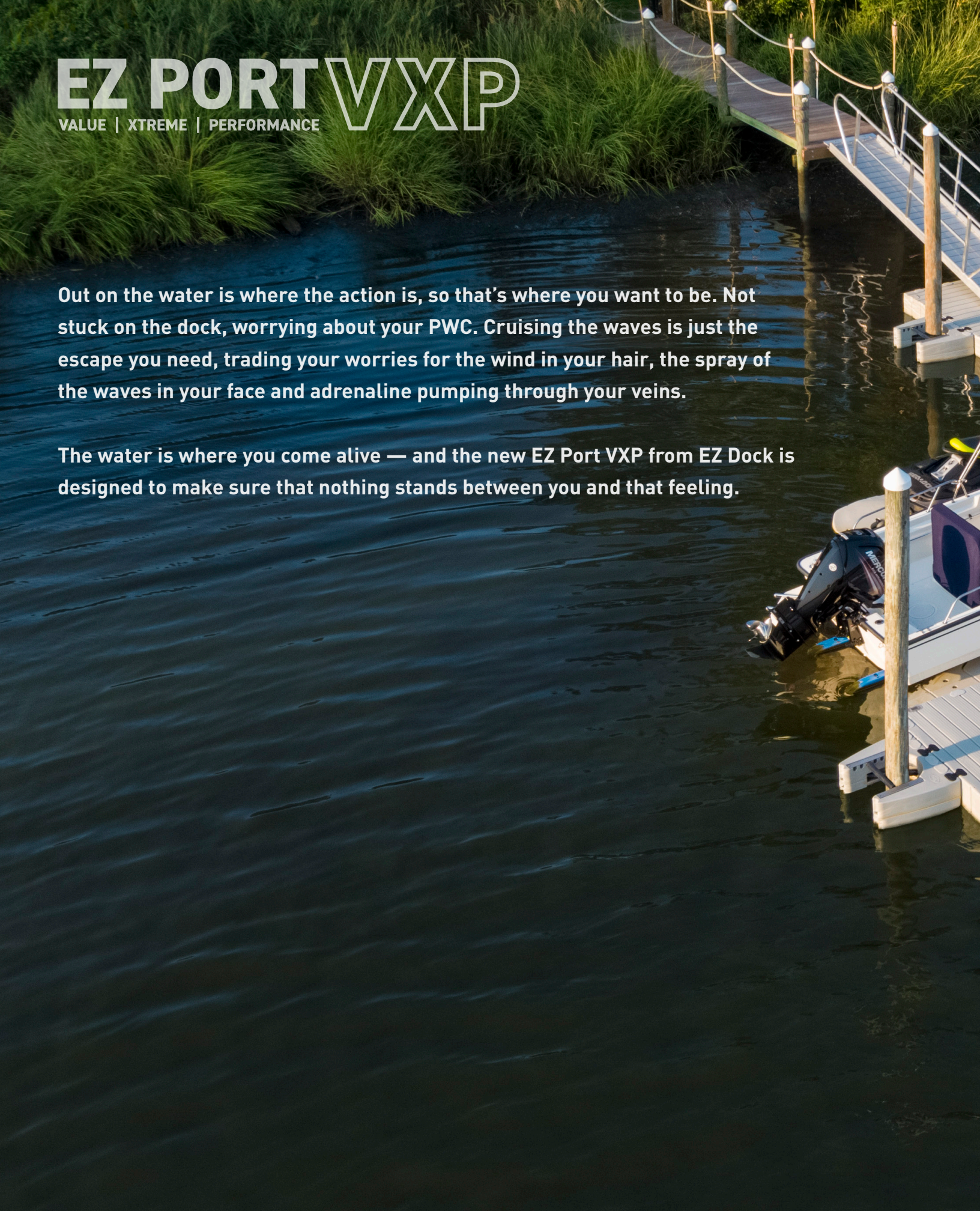



EZ PORT VXP

VALUE | XTREME | PERFORMANCE





EZ Port VXP

The EZ Port VXP gives you real peace of mind, knowing that your PWC is well-protected against the weather, waves, wakes, or sinking at the dock. It makes cleaning, maintaining and boarding your PWC as effortless as easing it onto the port or into the water. The VXP connects seamlessly with any EZ Dock system, is compatible with all existing docks, and can be secured to the shore or lakebed without a dock. It is designed to accommodate most recreation and rec-lite PWCs.

See the VXP in action

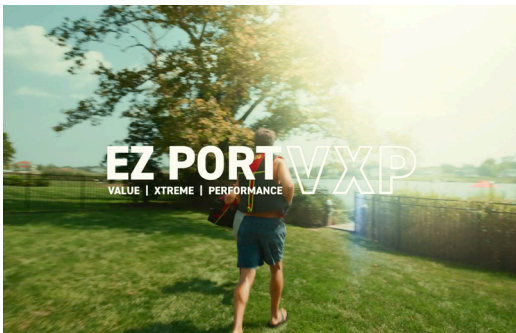

Visit the EZ Dock YouTube channel to see the EZ Port VXP in action.

Easy wheel adjustments



See how easily wheel adjustments can be made to fit your PWC model.

EZ PORT VXP

VALUE | XTREME | PERFORMANCE

The VXP is designed to make getting on and off the port and your PWC smooth, stable and easy. And, since the VXP keeps your PWC out of the water, it's easy to cover, clean, secure and access for maintenance.

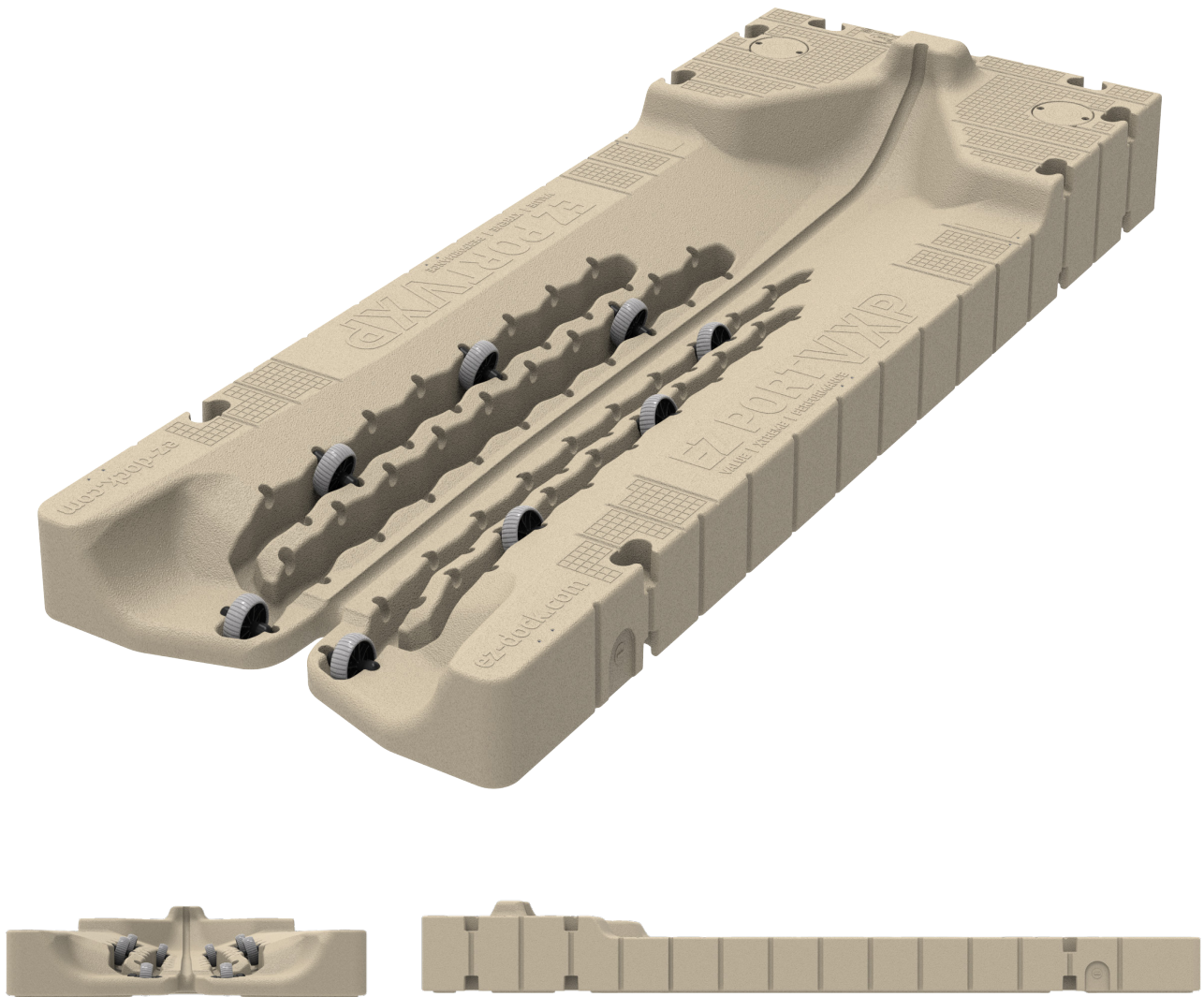

MODEL DESCRIPTION	SKU	DIMENSIONS	AREA	FLOTATION CAPACITY	WEIGHT
EZ PORT VXP	206037PW (BEIGE)	153" x 58.5" x 14.58"	62 sq ft	1,300 lbs	325 lbs
	206037PW-EZGR (GRAY)	(3.9m x 1.5m x 0.37m)	(5.8 sq m)	(590 kg)	(152 kg)



Keep your PWC safe and easy to use

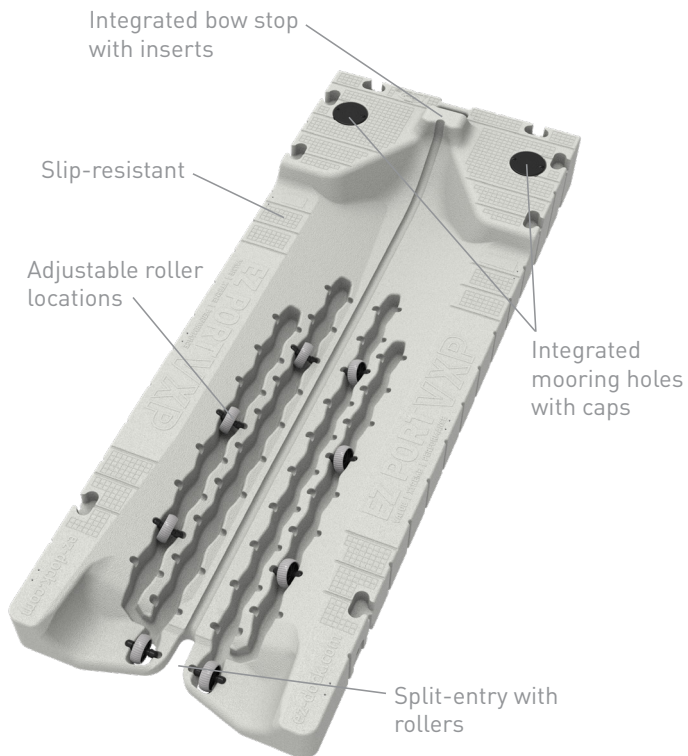

EZ Port VXP Features and Benefits:

- UV-16-protected, rotationally molded polyethylene
- Industry-leading impact resistance requires no environmentally harmful foam filling
- Patented understructure creates a stable and durable walking and porting surface
- Adjustable rollers adapt to all PWC brands or hull designs for effortless porting and launching
- Integrated bow stop for added security
- Seamlessly connects to any EZ Dock system
- Connects to any existing dock system or can be secured to the shore or lakebed without a dock
- Keeps any rec or rec-lite PWC high and dry, protecting your investment
- Available in beige or gray

Roll your PWC on and off the port

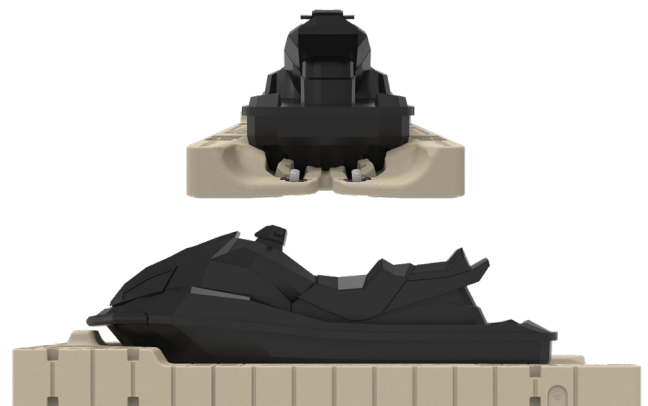

EZ PORT MAX

MODULAR | ADAPTABLE | EXPANDABLE

One of water's most fascinating qualities is how it takes on the shape of whatever is around it, its form and currents always flowing, moving and changing, creating its own natural sense of order.

That same dependable, orderly flow was also the inspiration behind EZ Port MAX from EZ Dock — a system of smooth-rolling ports that can be configured to change easily along with the needs of your waterfront.





EZ PORT MAX

MODULAR | ADAPTABLE | EXPANDABLE





EZ Port MAX Features and Benefits

- Modular, Adaptable, and Xpandable to maximize slip space for unlimited PWC storage options
- Smooth-gliding rollers provide easy, low-impact loading and unloading
- Can be customized for tight slips and tandem inlines
- Accommodates all PWCs
- Perfect for rental applications to increase efficiency and maximize profitability
- Ideal for all levels of PWC operators

Watch the EZ Port MAX testimonial video



Visit the EZ Dock YouTube channel to hear how easy the EZ Port MAX makes loading and unloading PWCs.



EZ PORT MAX

MODULAR | ADAPTABLE | EXPANDABLE

The modular, adjustable and expandable EZ Port MAX PWC port system is built to accommodate multiple PWCs of different shapes. The EZ Port MAX is one of the most flexible options available and can be customized to maximize slip spaces with tandem inlines that help you accommodate more PWCs per slip. Just configure the design that best suits your waterfront and adjust the design any time your needs change.

The EZ Port MAX is a flexible system designed for single, multiple, or inline ports to accommodate multiple PWCs.

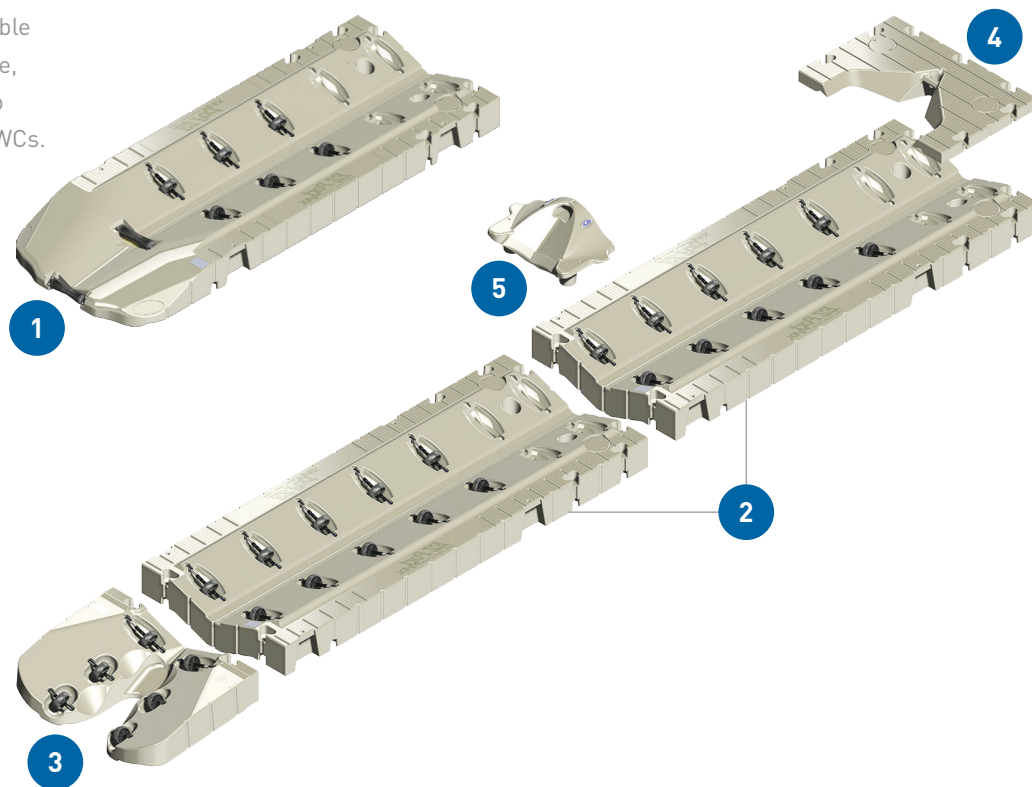

	MODEL DESCRIPTION	SKU	DIMENSIONS	AREA	FLOTATION CAPACITY	WEIGHT
1	EZ PORT MAX ENTRY	206030PW (BEIGE)	149" x 59" x 10" (3.8 m x 1.5 m x 25 cm)	62 sq ft (5.8 sq m)	1,380 lbs (626 kg)	266 lbs (120.6 kg)
		206030PW-EZGR (GRAY)				
2	EZ PORT MAX EXTENSION	206031PW (BEIGE)	146" x 59" x 10" (3.7 m x 1.5 m x 25 cm)	60 sq ft (5.6 sq m)	1,400 lbs (635 kg)	266 lbs (120.6 kg)
		206031PW-EZGR (GRAY)				
3	EZ PORT MAX EASY-LIFT ENTRY	206033EX (BEIGE)	44" x 59" x 10" (1.1 m x 1.5 m x 25 cm)	N/A	400 lbs (182 kg)	95 lbs (43 kg)
		206033EX-EZGR (GRAY)				
4	EZ PORT MAX FULL BOW SECTION	206025BS (BEIGE)	39" x 59" x 11" (1 m x 1.5 m x 28 cm)	N/A	-	60 lbs (27.2 kg)
		206025BS-EZGR (GRAY)				
5	EZ PORT MAX SMALL BOW SECTION	206027BS (BEIGE)	39" x 21" x 15" (1 m x 0.5 m x 38 cm)	N/A	-	12 lbs (5.4 kg)
		206027BS-EZGR (GRAY)				



1. EZ Port MAX Entry

This base unit can be used with an EZ Port MAX Extension, Full Deck Bow Section and a Small Bow Section to create an inline multiport lift.



2. EZ Port MAX Extension

The extension can be combined with the EZ Port MAX Entry or the Easy-Lift Entry for unlimited PWC storage options.

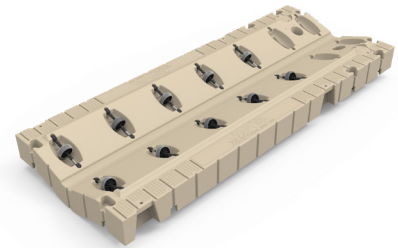

3. EZ Port MAX Easy-Lift Entry

This entry section is designed to attach to the EZ Port MAX extension, making it easier and softer to port your watercraft. The Easy-Lift Entry roller configuration eliminates all keel rollers, keeping the PWC stable and centered on the port.



4. EZ Port MAX Full Bow Section

This add-on section can be used to finish off your inline system.

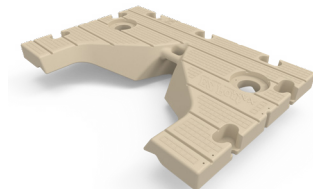

5. EZ Port MAX Small Bow Section

This add-on section is used to separate PWCs in an inline application.





Leave all your worries behind before you ever head out to the waterfront. EZ Dock has the selection of ports you need to make taking care of your PWC as carefree as taking it out for a day of fun on the water.



LOW-MAINTENANCE & BAREFOOT FRIENDLY

- EZ Dock's polyethylene docks are durable and slip resistant
- Won't splinter or rot, never needs to be painted
- Cleans easily with soap and water
- UV-16 ultraviolet provides long-term protection against fading, cracking and degradation from the sun
- Protected by an eight-year limited warranty

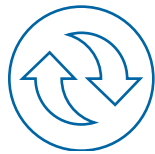

ADAPTABLE DESIGN

- Unique design delivers outstanding load capacity, functionality, and safety
- Compatible for use with a variety of dock sections, boat/PWC lifts, and kayak launches
- Easily customizable design to make your perfect waterfront retreat

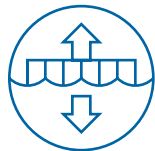

FLEXIBLE FLOTATION TECHNOLOGY

- Flotation chamber and pylon design provide additional stability on the water
- Constructed for optimal strength and structural integrity
- Dock sections adapt easily to changing water conditions and levels



INNOVATIVE COUPLING

- Made of recycled materials
- Nuts and bolts made of heavy-duty, rust-resistant composite
- Strength and durability even in the harshest weather conditions

FOR MORE INFORMATION ABOUT EZ DOCK PWC PORTS, GO TO EZ-DOCK.COM OR CONTACT YOUR LOCAL EZ DOCK DEALER.



EZ Dock, Inc
878 HWY 60
Monett, MO 65708
1-417-235-2223 1-800-654-8168

For a complete list of products, visit ez-dock.com

EZ Dock may introduce new colors, products, accessories and options throughout the year. Specifications and products listed are subject to change without notice. Some products may be shown with additional or optional equipment not available through EZ Dock. Specifications may vary for international shipments. Please check with your local dealer for more information. EZ Dock is a product of the U.S.A.

© 2019 EZ Dock, Inc. All rights reserved.

